

使用方法及功能

1. 認識色彩：

教導幼兒認識各種色彩，引導幼兒運用不同顏色積木，將其排列組合出創意圖形，於遊戲中學習，強化對形狀與邏輯的概念。

2. 手眼腦協調：

練習將不同造型的積木，做各式各樣平面或立體的堆疊，可增加幼兒手指靈活運動，提升幼兒智能與手眼腦的協調能力，並可作為提升專注力的訓練。

3. 空間概念認知：

各色積木皆有一定比例設計，可進行各種角度的堆疊排列，能盡情發揮想像力創意，創造各種組合變化。內附2D示範圖與3D題庫，請指導者多多鼓勵幼兒，激發腦力，並可增進與幼兒間的互動。



偉志實業有限公司
World Zebra Inc, Ltd.

腦筋急轉彎

WISDOM PUZZLE SET

趣味積木組



2D 3D 題庫手冊

偉志實業有限公司
World Zebra Inc, Ltd.

操作說明

本操作手冊提供四種題型，與題解合計五大單元。

以積木外型之單位元作為題目基本，依各題所提供的底圖，或數量之單位元做解答依據；A、B、C、D四大題庫又各分二單元（如目錄所示），以A題庫為例：單元一（第1頁）為底圖式題，單元二（第5頁）為填空題。初階者可先由任一大題庫之第二小單元開始。

題目豐富趣味，積木變化多端，適合各年齡操作使用，更可培養兒童的數學、邏輯與色彩概念。

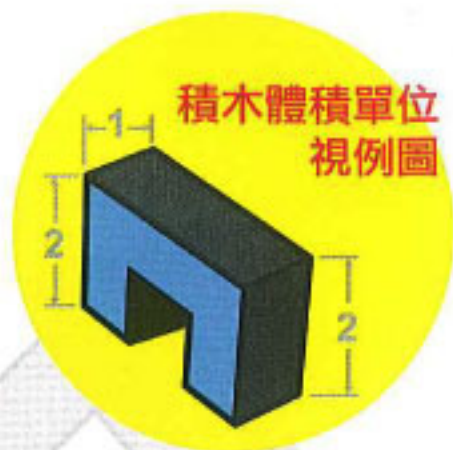

A	各類矩形組合.....	01
	填空圖示題.....	05
B	各種平面組合變化.....	06
	填空圖示題.....	09
C	趣味造型組合.....	10
	填空圖示題.....	18
D	幾何立體造型組合.....	19
	元件提示圖題.....	22
E	題庫解答.....	27

CONTENTS



• 依照圖示中之單位數，拼組出正確圖樣。



! 此題亦可運用收納盒"蓋"拼組!

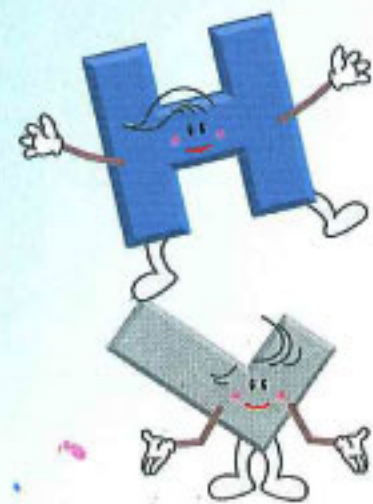

! 此題亦可運用收納盒“蓋”拼組!

4x4

- 依照圖示中之單位數，拼組出正確圖樣。

6x6



- 依照圖示中之單位數，拼組出正確圖樣。

4x5

4x6

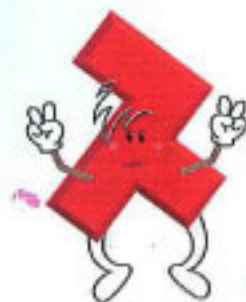
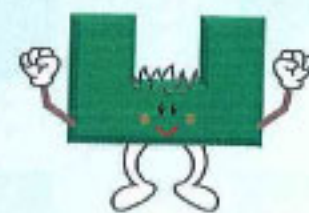

- 依照圖示中之單位數，拼組出正確圖樣。



8x8

! 此題亦可運用收納盒拼組 !

- 請依照圖中積木提示，以第1~4頁圖框拼組。

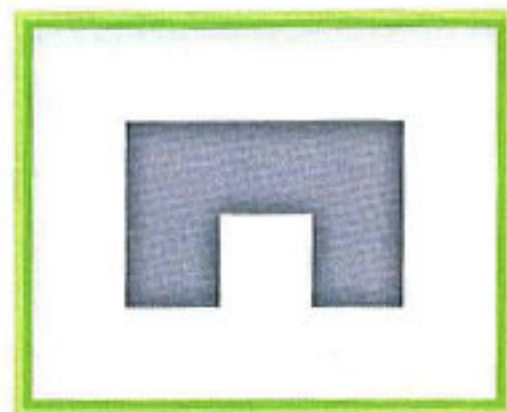

▲ 4x5

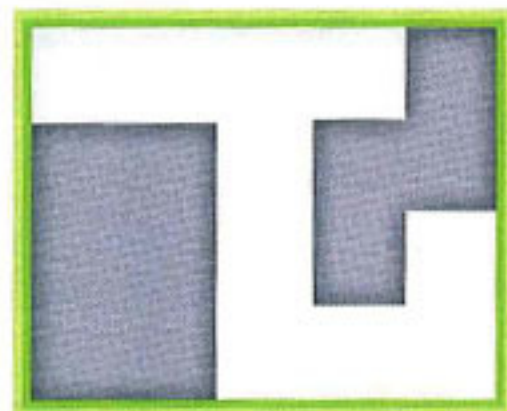

▲ 4x5

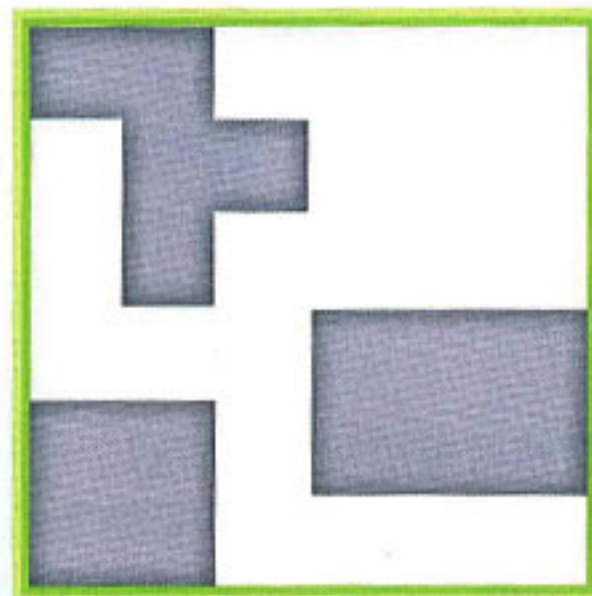

▲ 6x4



▲ 4x6

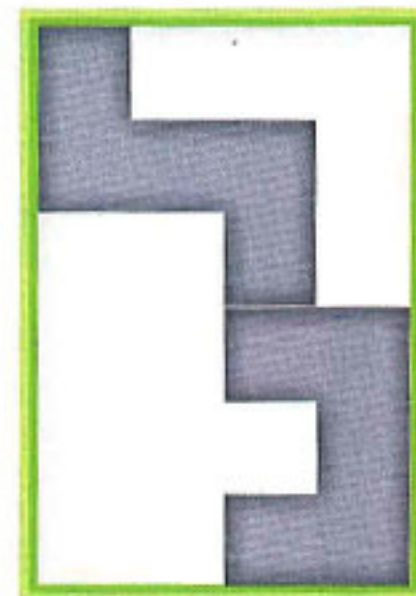

▲ 4x6

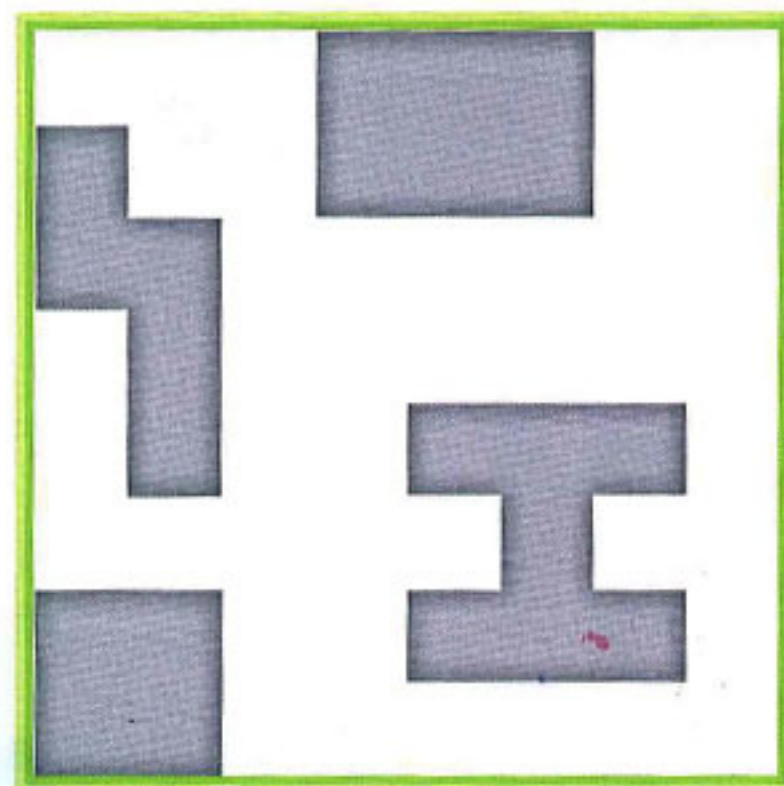

▲ 8x8

- 依照圖示中之單位數，拼組出正確圖樣。

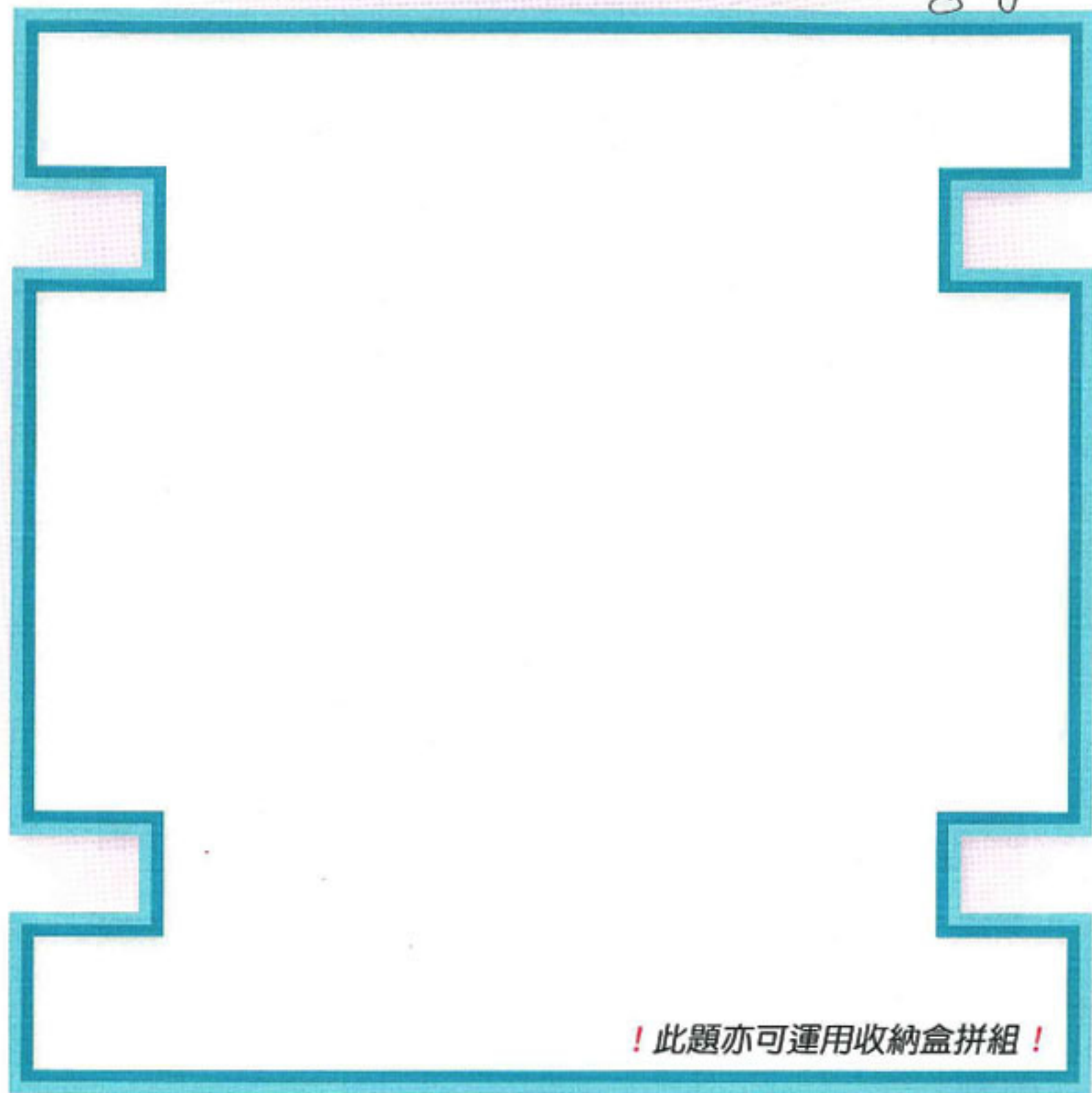

! 此題亦可運用收納盒拼組 !

8x8

- 依照圖示中之單位數，拼組出正確圖樣。

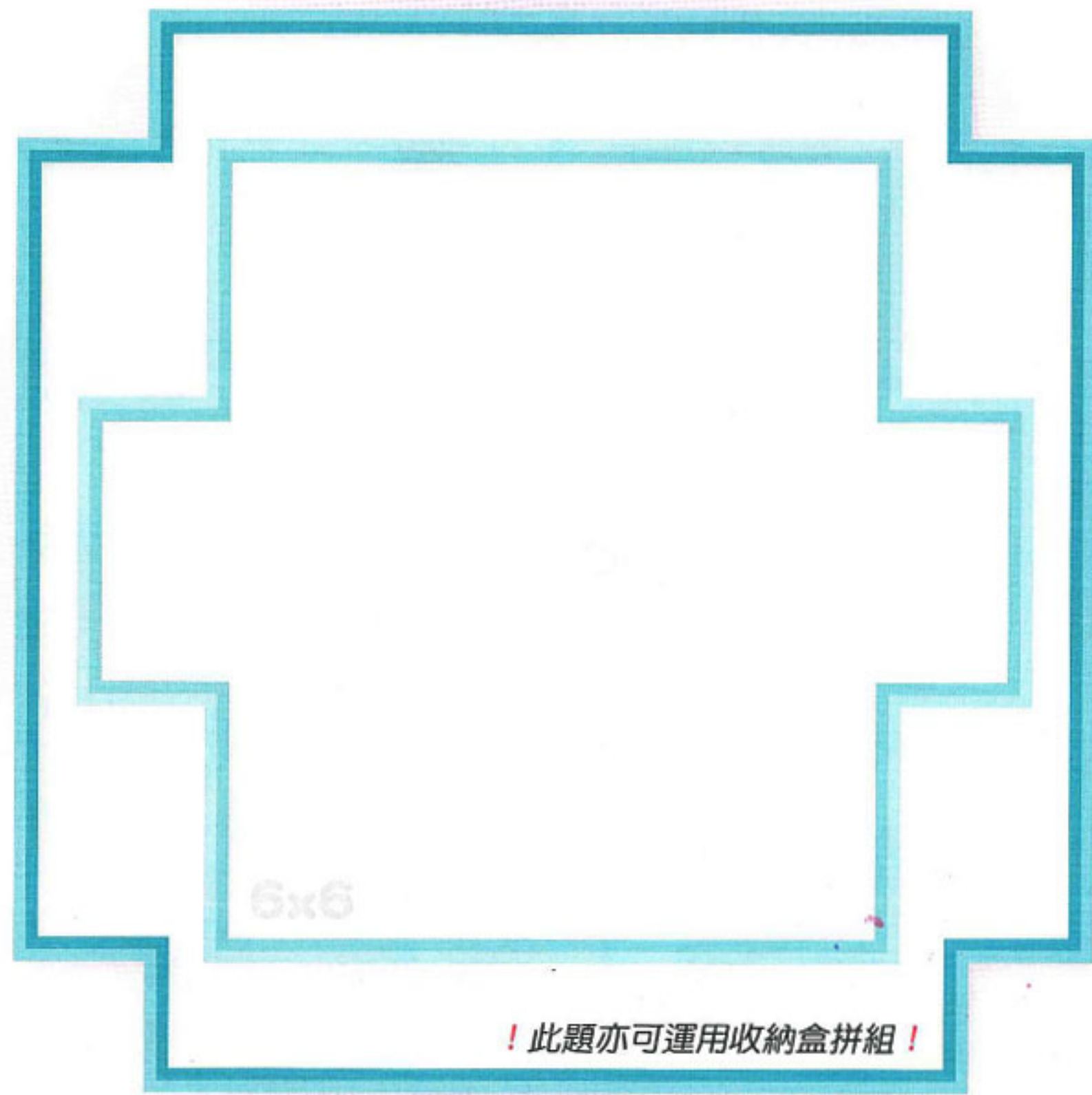

! 此題亦可運用收納盒拼組 !

8x8

• 依照造型圖示，
找出適合積木，
拼組入圖框內。

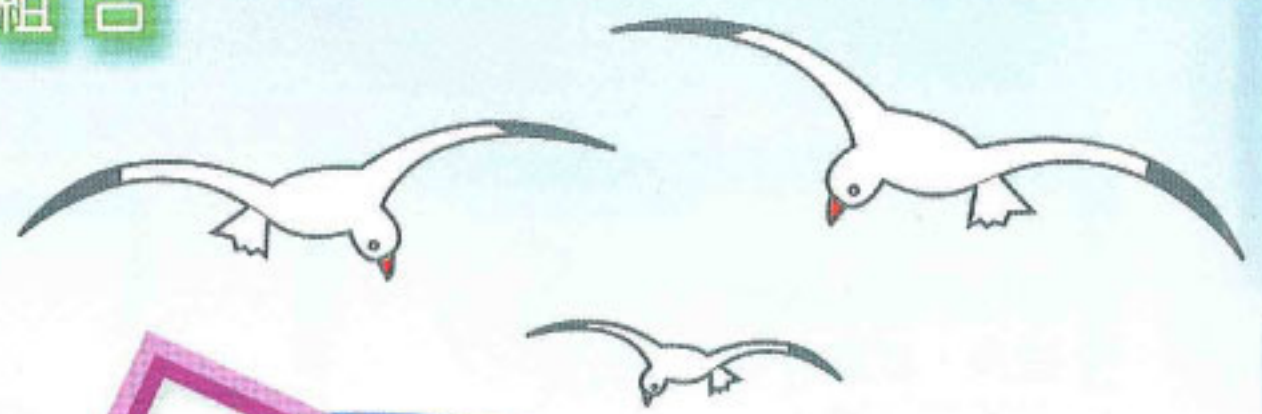

題庫圖示大小為實際尺寸

10 版權所有，請勿翻印

題庫圖示大小為實際尺寸

版權所有，請勿翻印 11

C 趣味造型組合



• 請依照圖中積木提示，以第12~19頁圖框拼組。

* 黑色圖塊為積木背/底面。

題庫圖示大小非實際尺寸

立體幾何造型組合 D

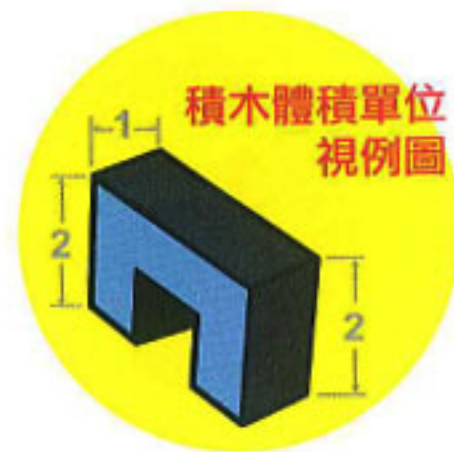

• 請找出適合的積木，拼組出圖示之立體幾何造型。

* 可運用反面/黑色面拼組。

* 體積之單位數如圖示。

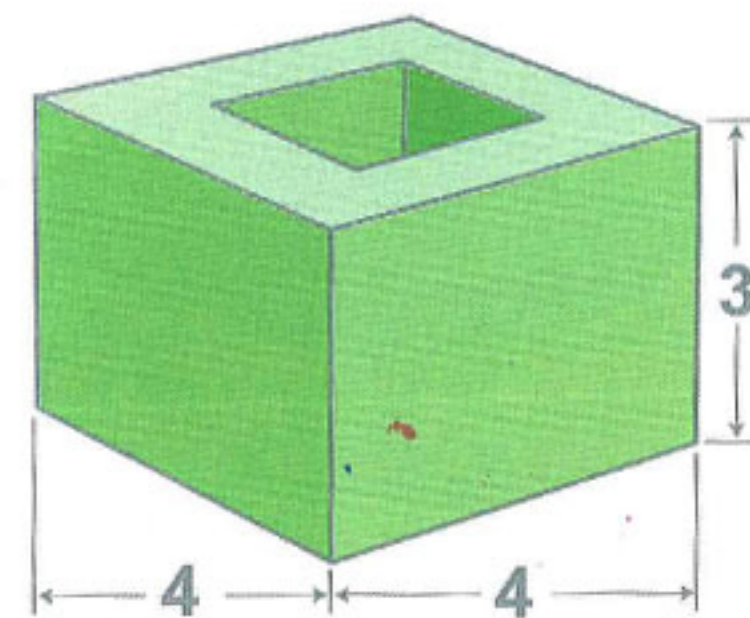
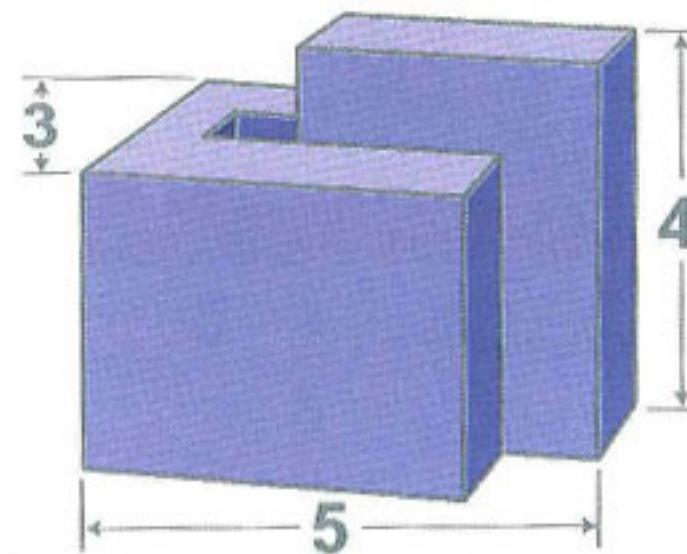
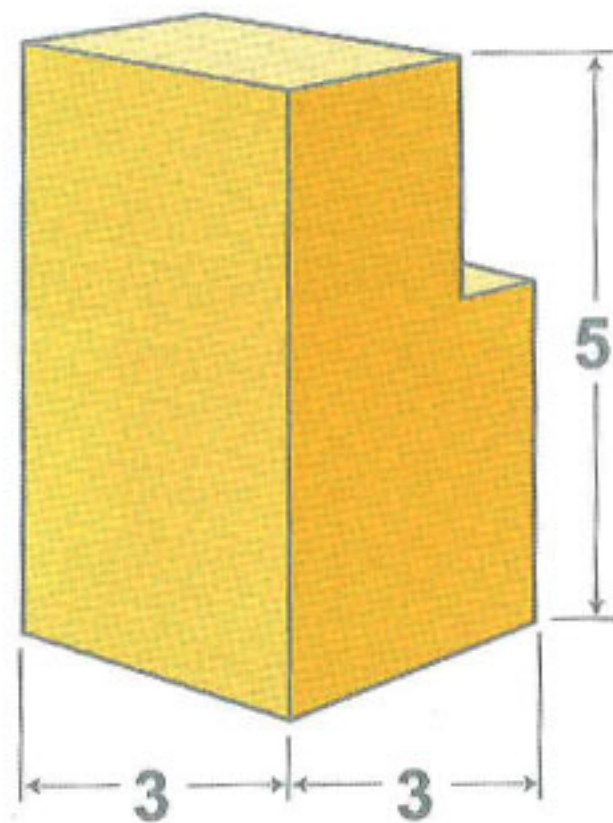

題庫圖示大小非實際尺寸

版權所有，請勿翻印

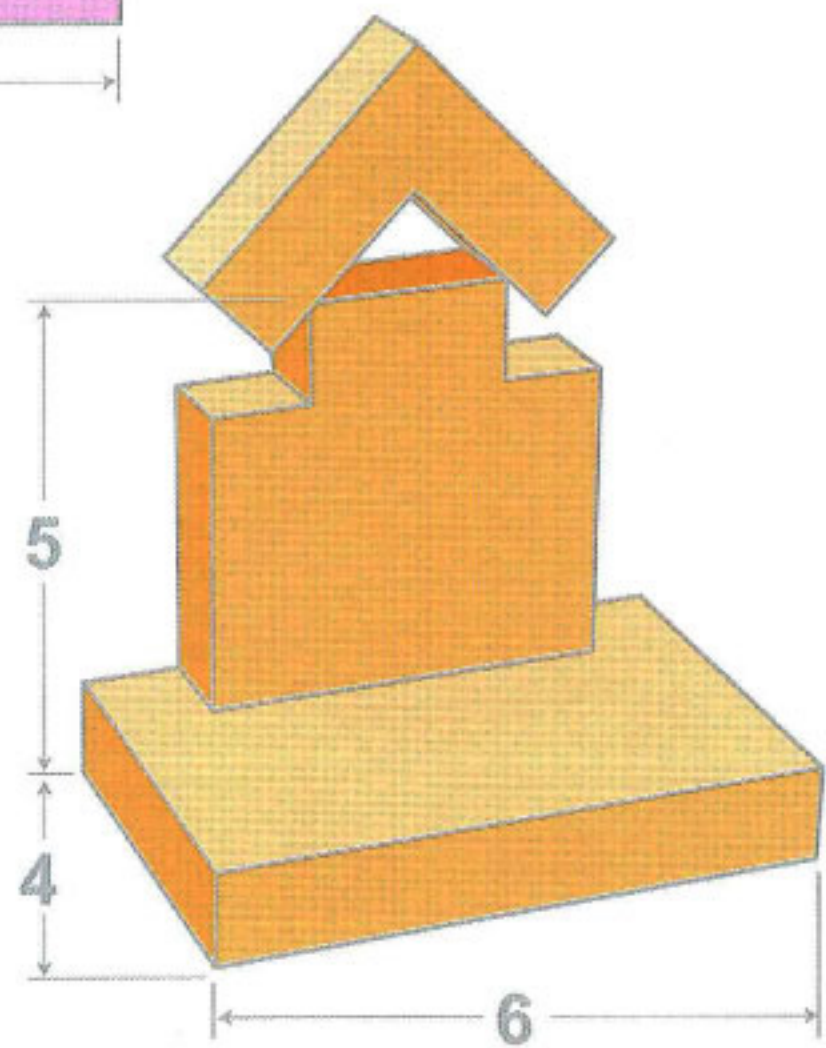
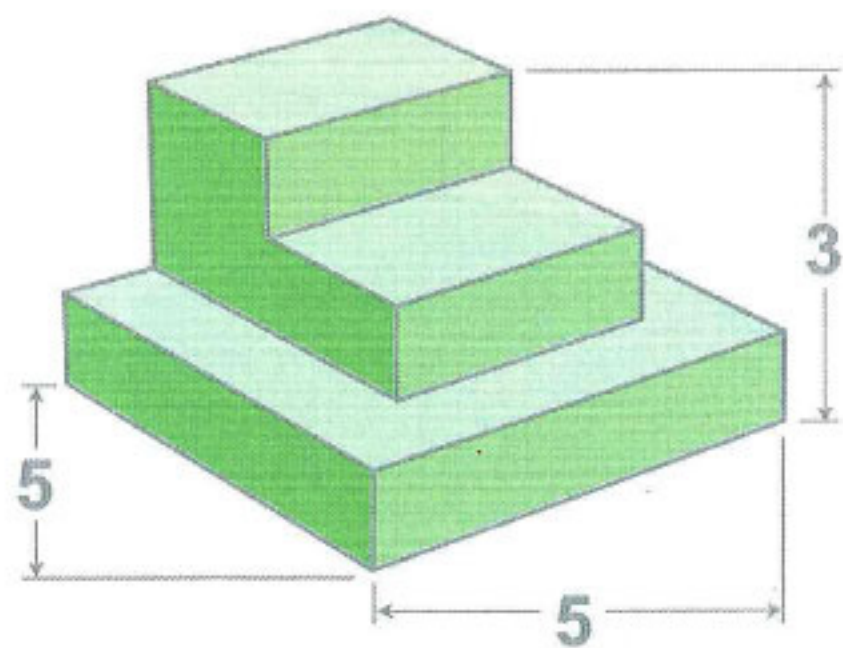
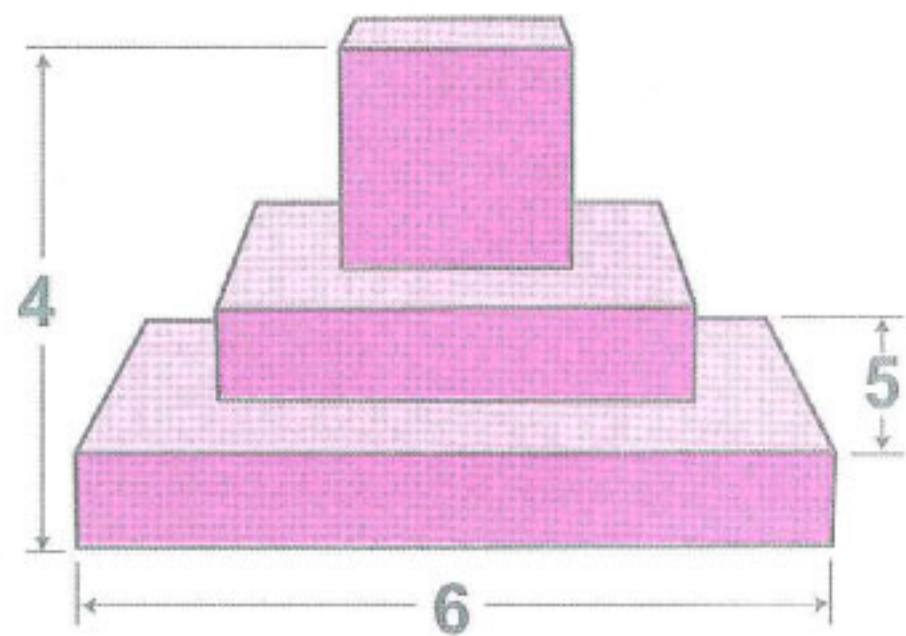
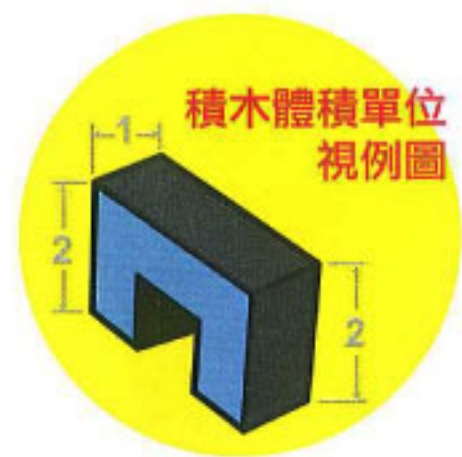

- 請找出適合的積木，拼組出圖示之立體幾何造型。
- * 可運用反面/黑色面拼組。
- * 體積之單位數如圖示。

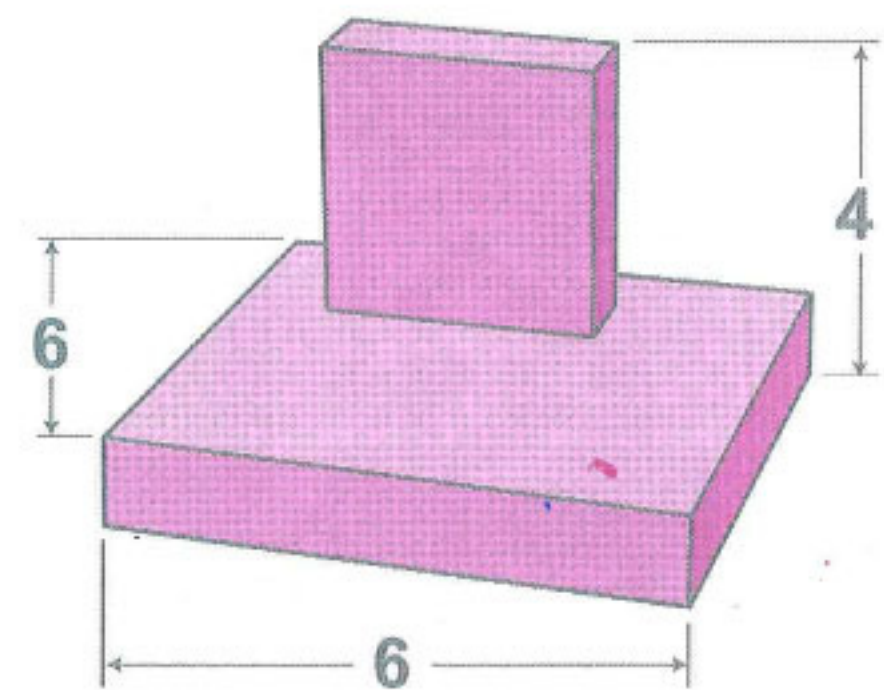
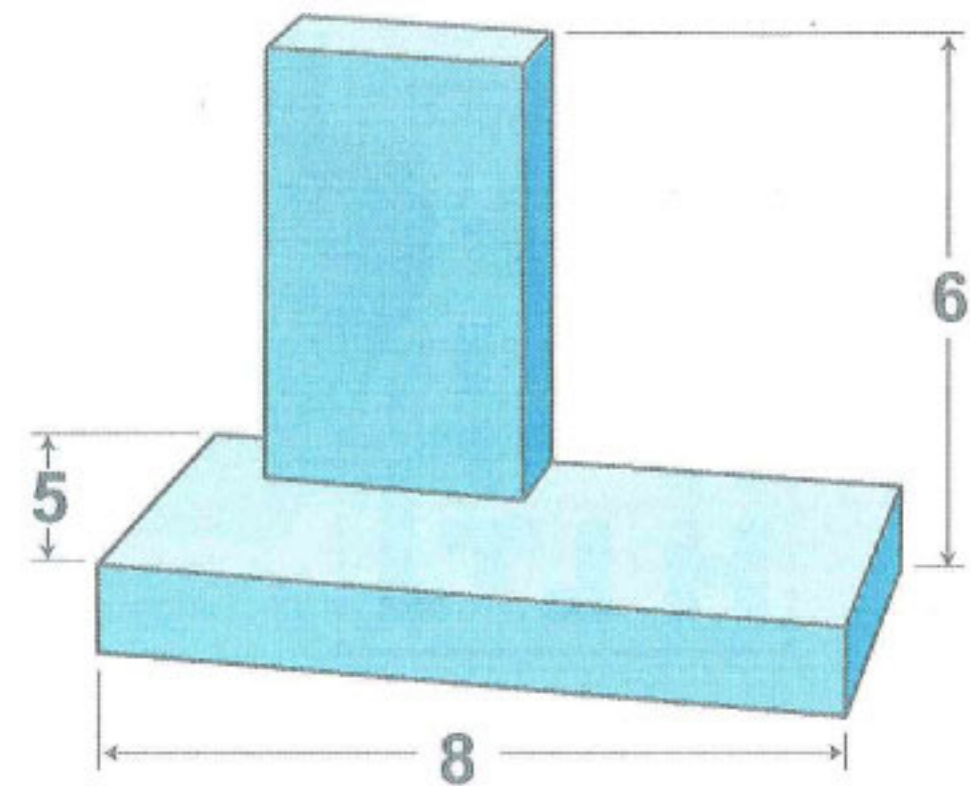
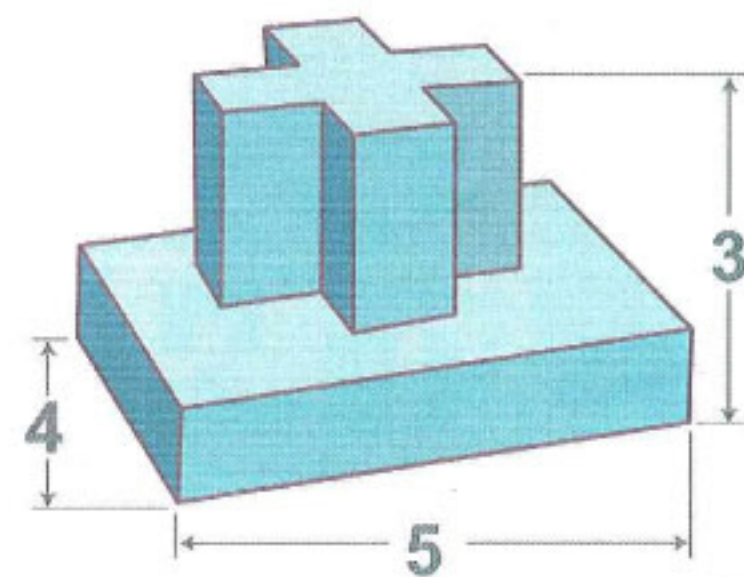
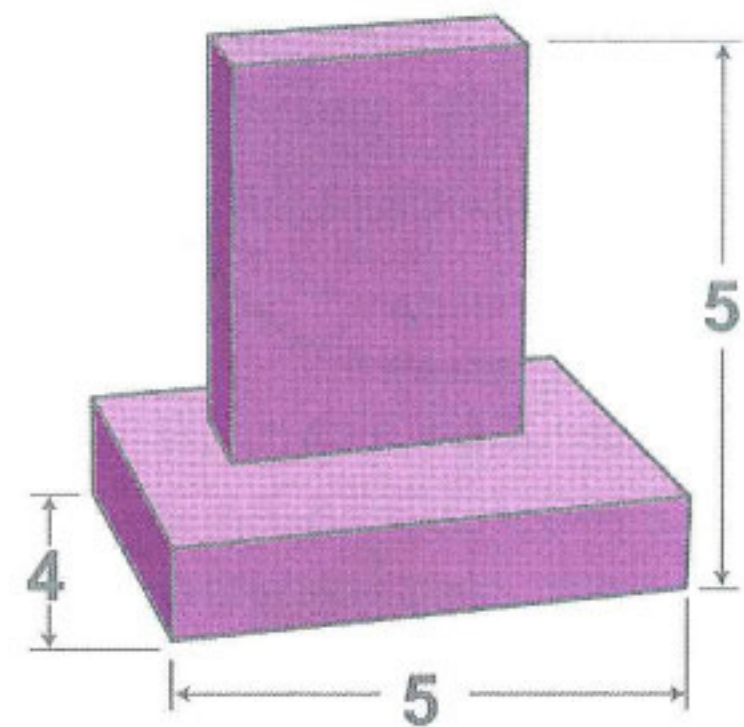

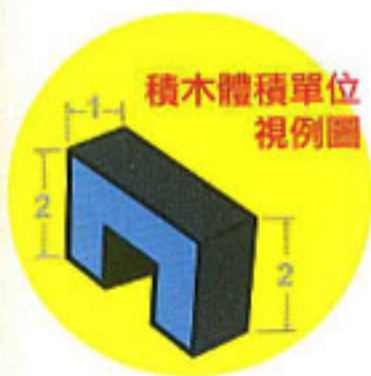

可運用之積木元件提示

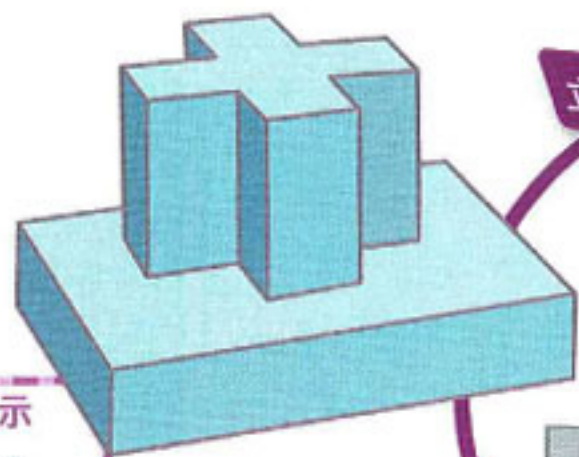

立體造型三面視圖

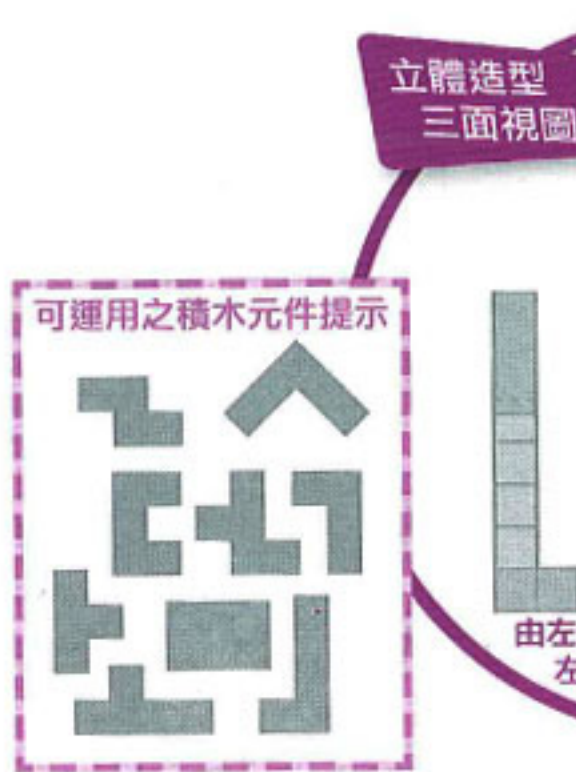
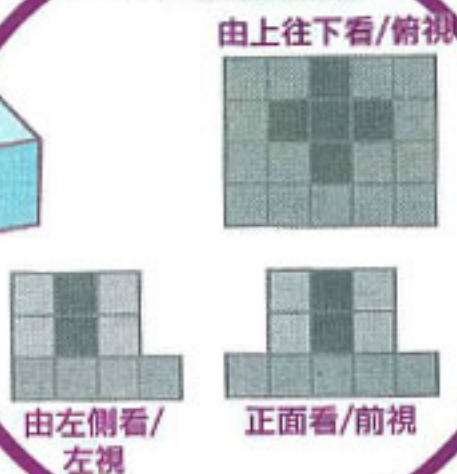

立體造型三面視圖

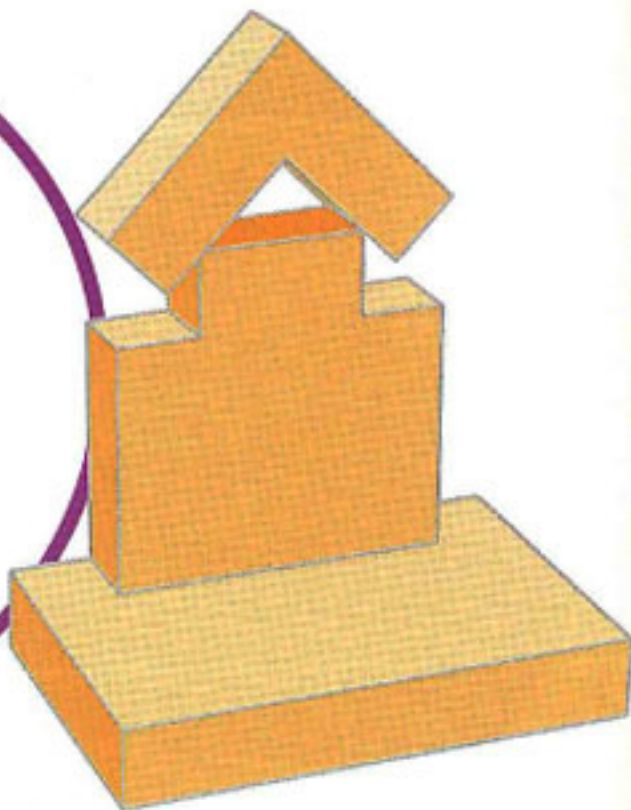
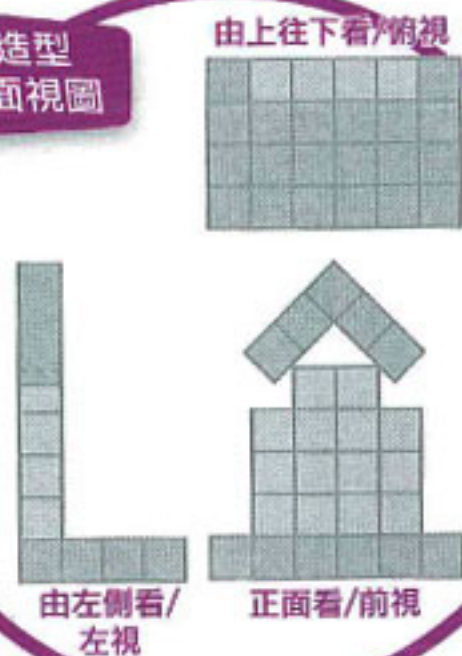

立體造型三面視圖

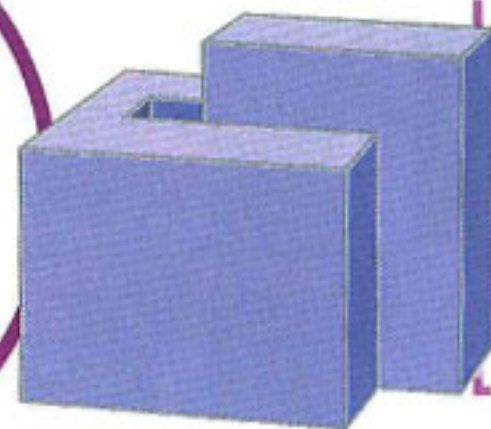
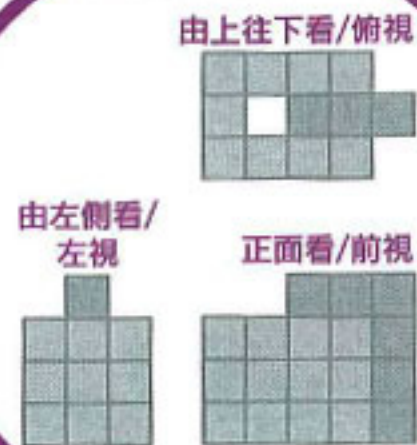

可運用之積木元件提示

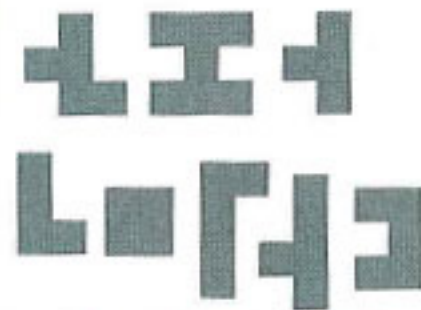

- 請找出適合的積木，拼組出圖示之立體幾何造形。
- * 請年長者教導幼兒參考三視圖拼組。
- * 積木體積單位數，如圈內圖示之方塊數。

立體造型三面視圖

可運用之積木元件提示

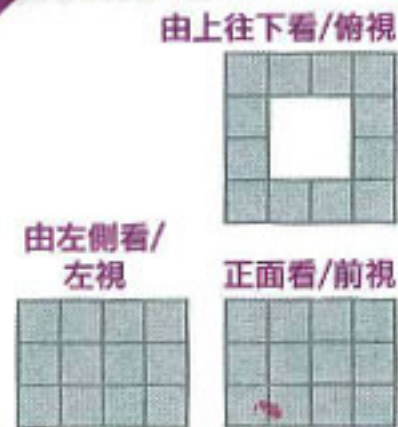
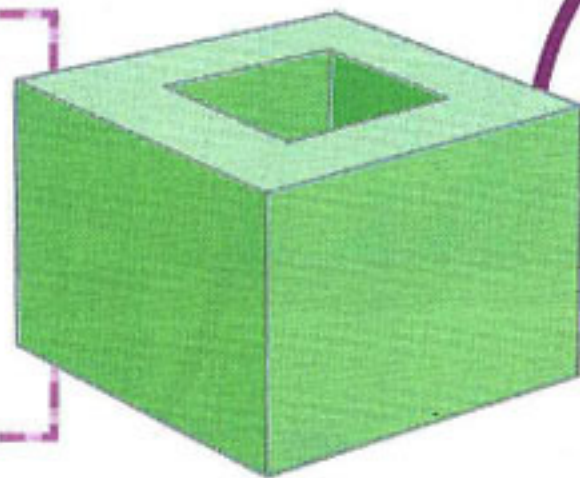
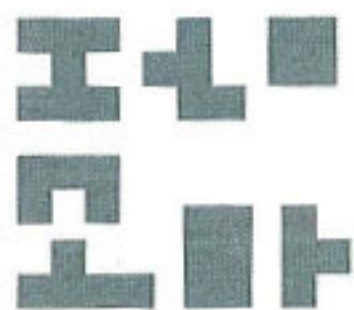

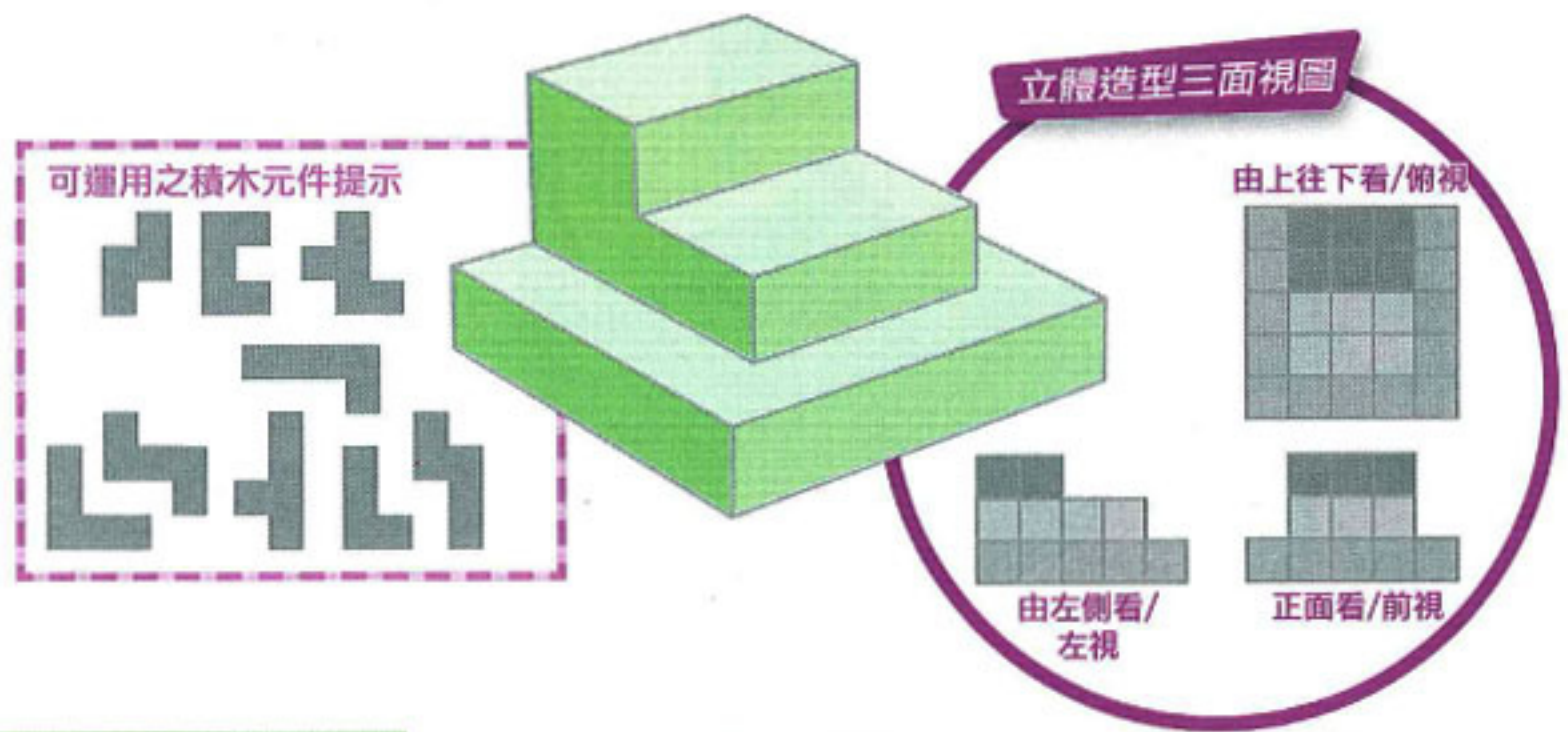
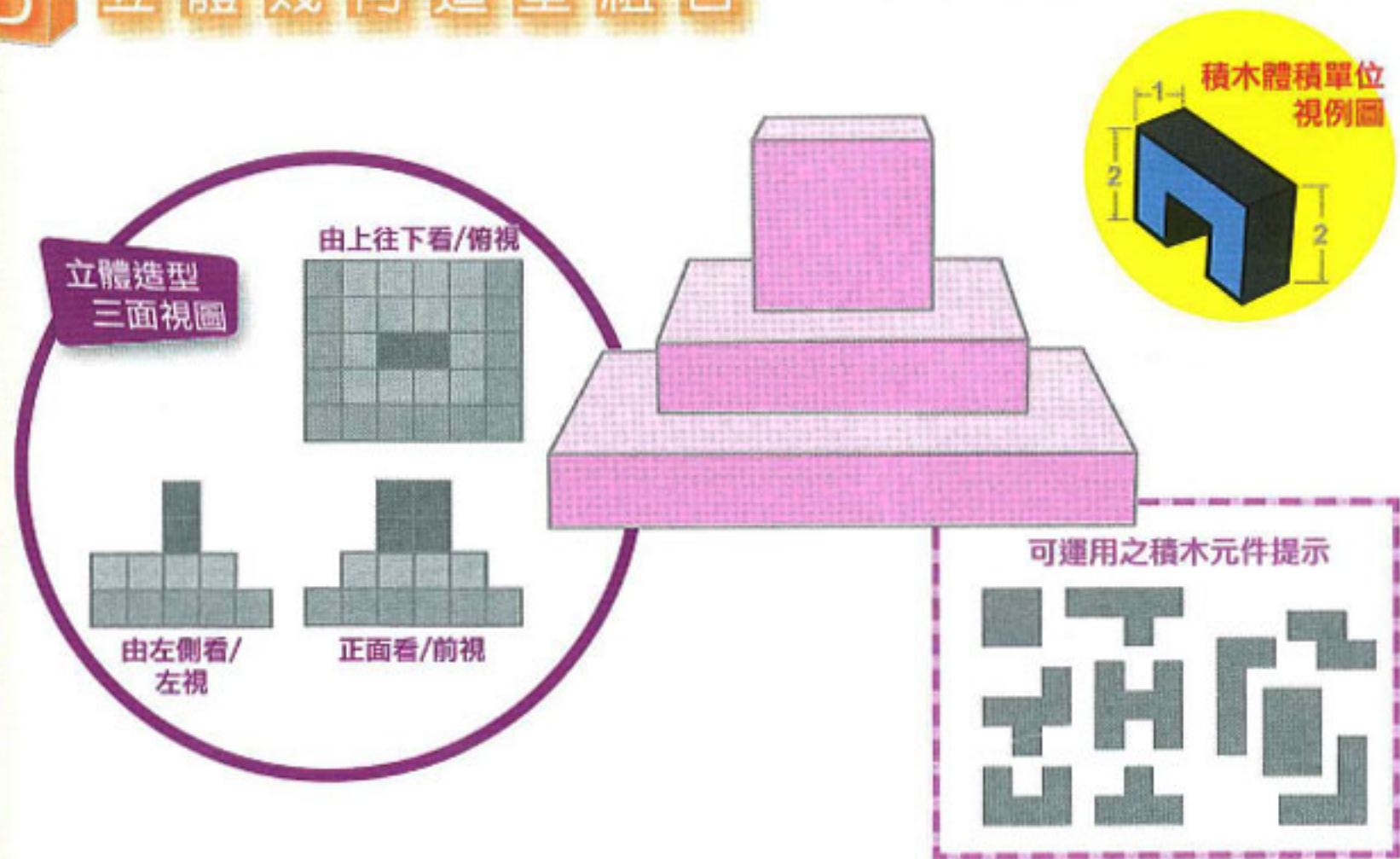

- 請找出適合的積木，拼組出圖示之立體幾何造形。
- * 請年長者教導幼兒參考三視圖拼組。
- * 積木體積單位數，如圈內圖示之方塊數。

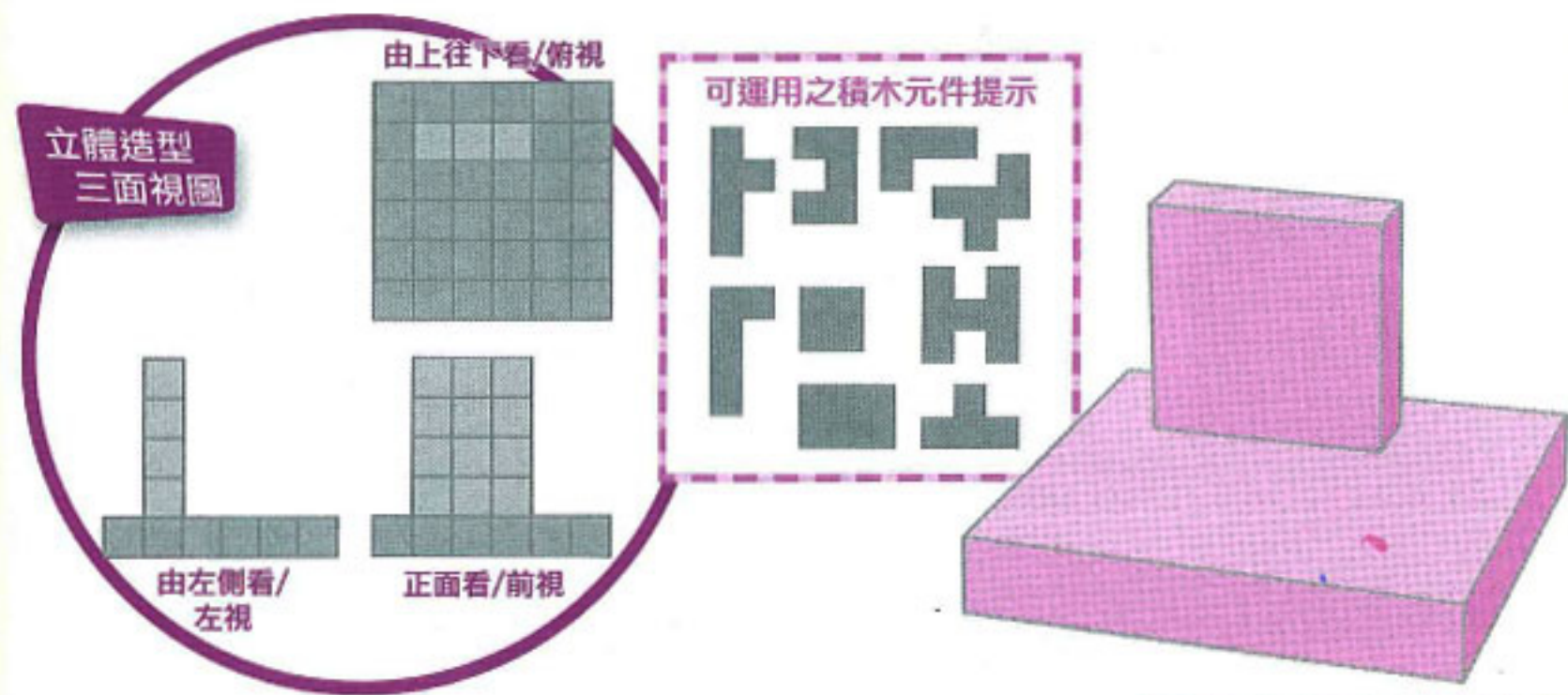
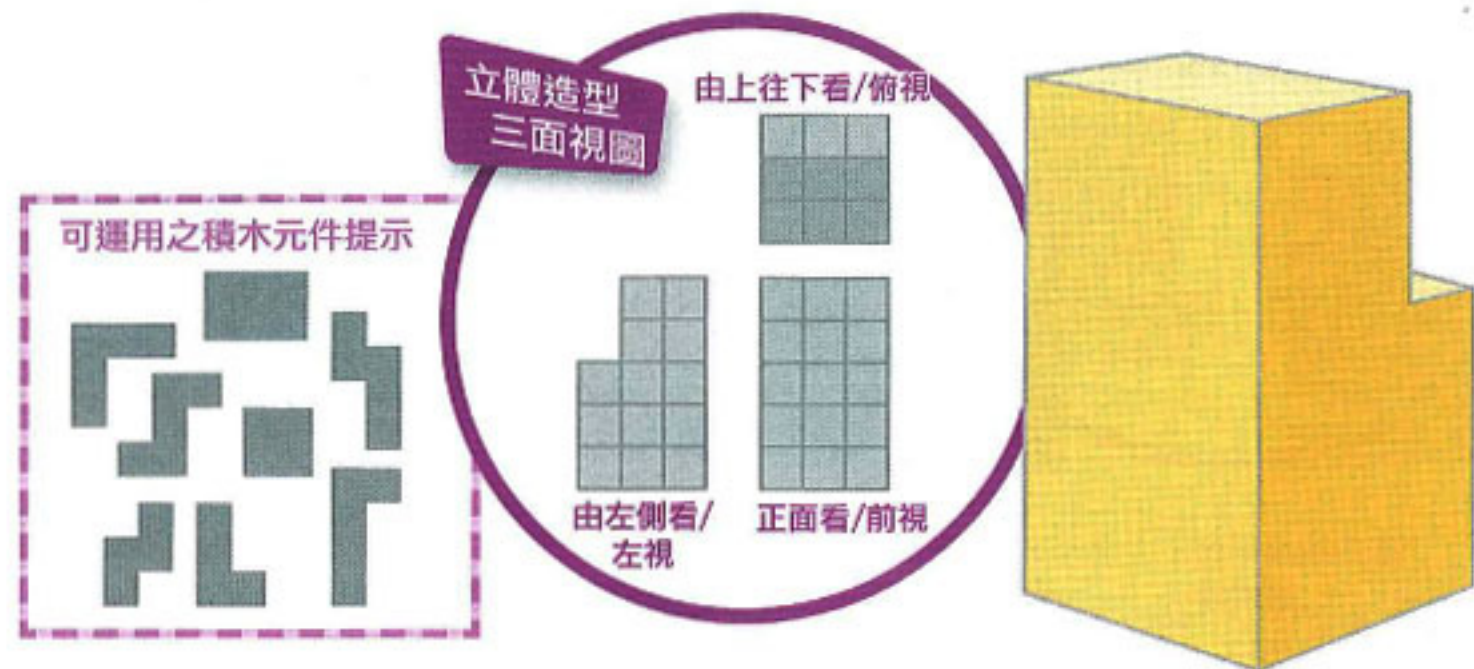

D 立體幾何造型組合

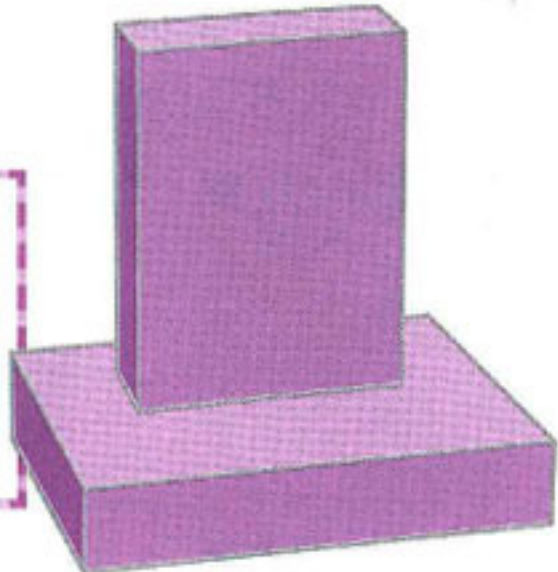
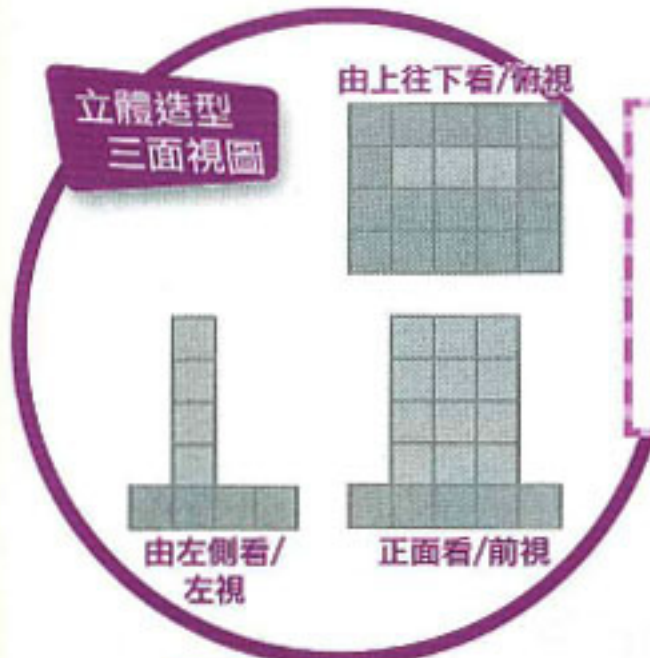

- 請找出適合的積木，拼組出圖示之立體幾何造型。
- * 請年長者教導幼兒參考三視圖拼組。
- * 積木體積單位數，如圈內圖示之方塊數。

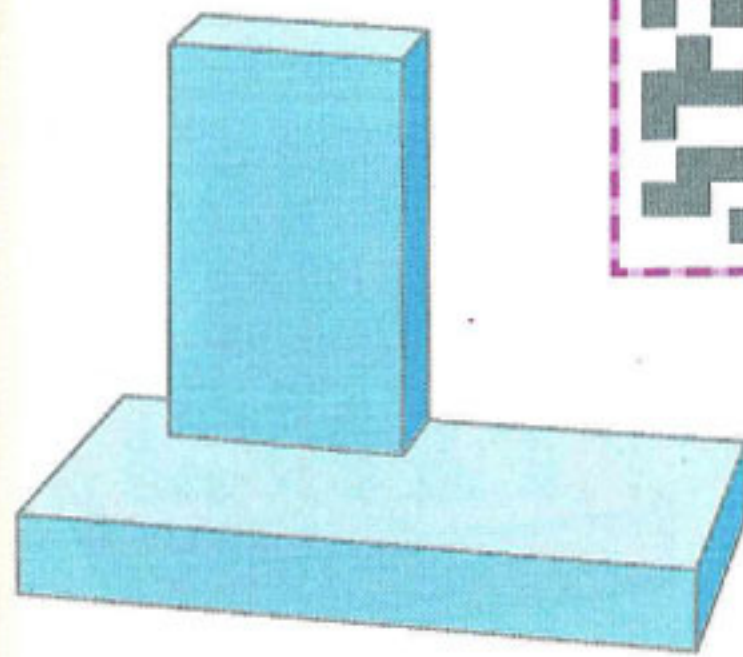
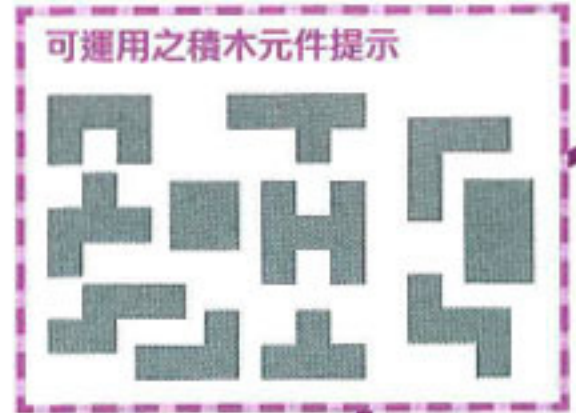
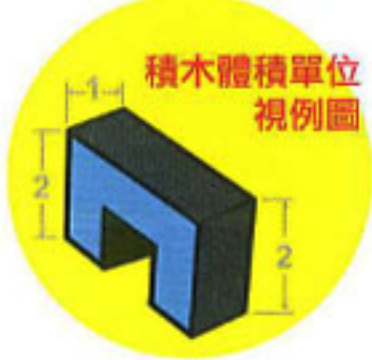

立體造型
三面視圖

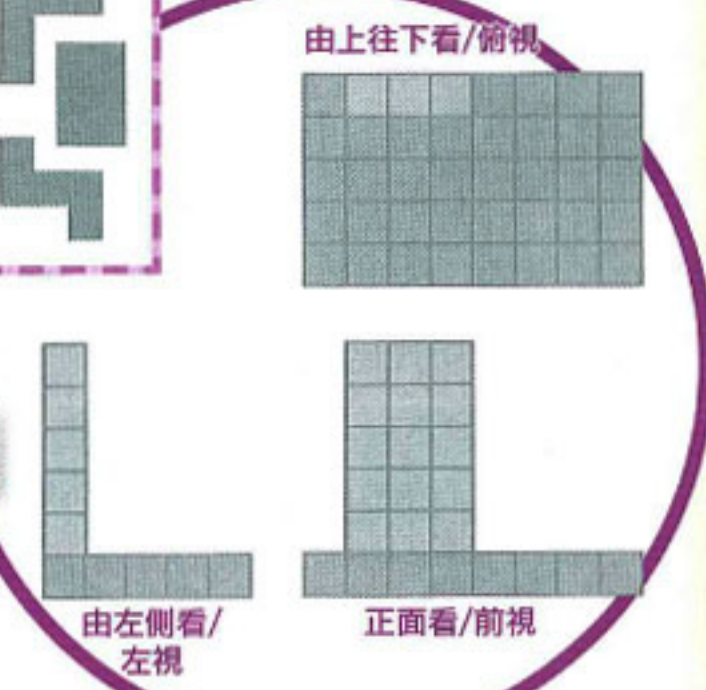

題庫解答 E

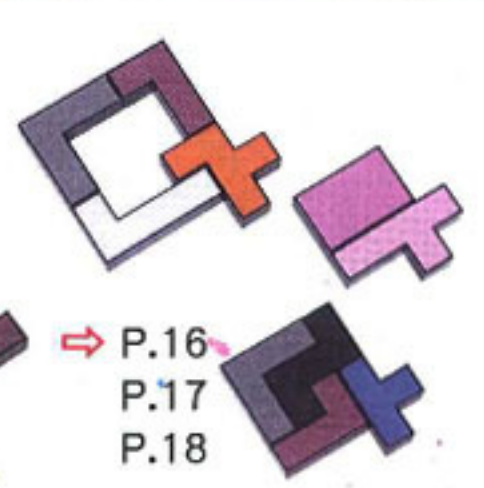
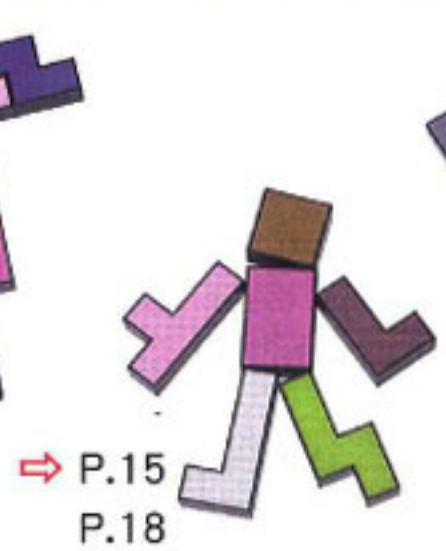
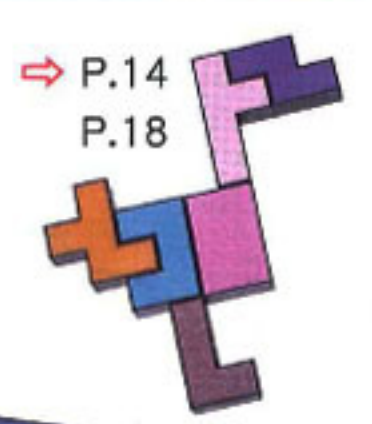
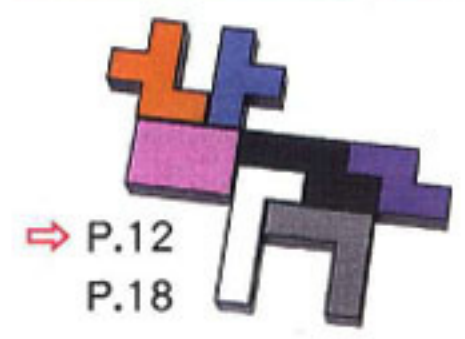
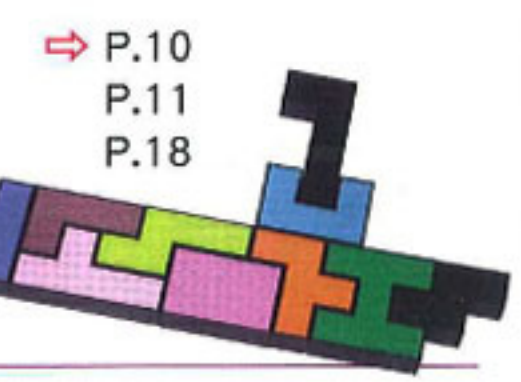
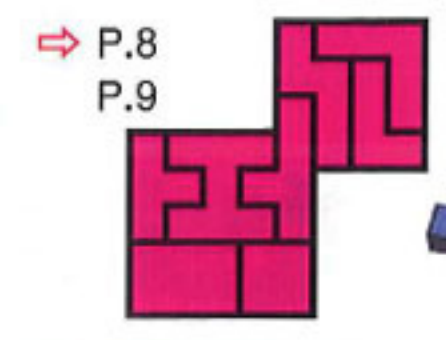
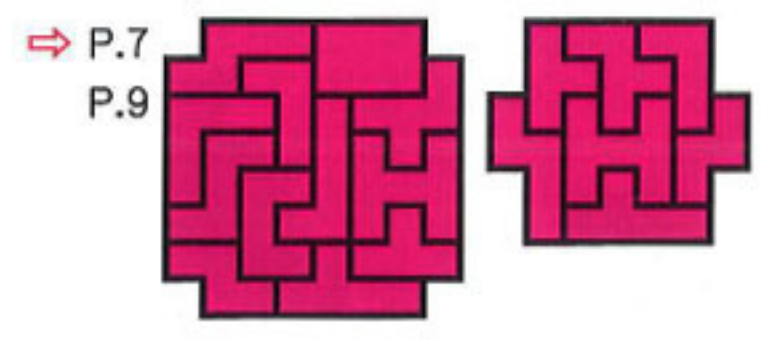
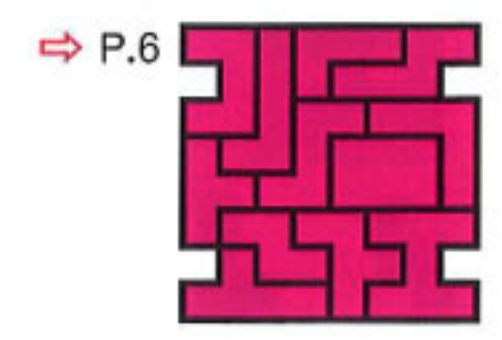
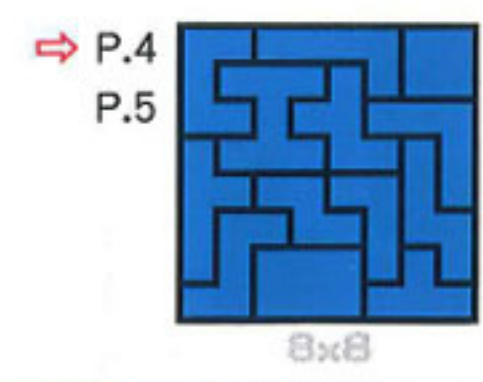
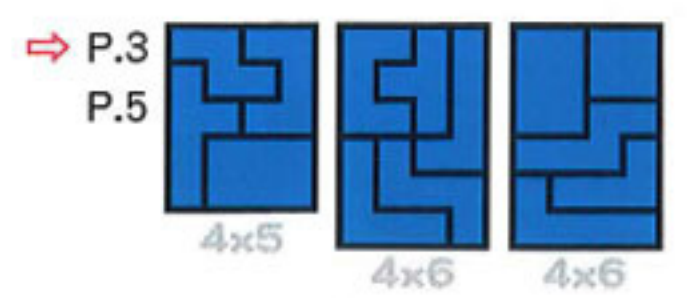
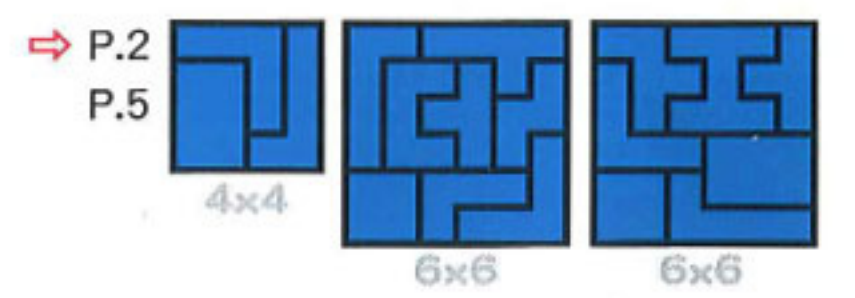
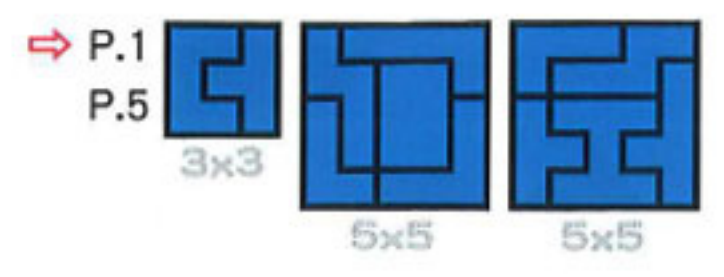

← P.19
P.25

* 黑色為積木背面

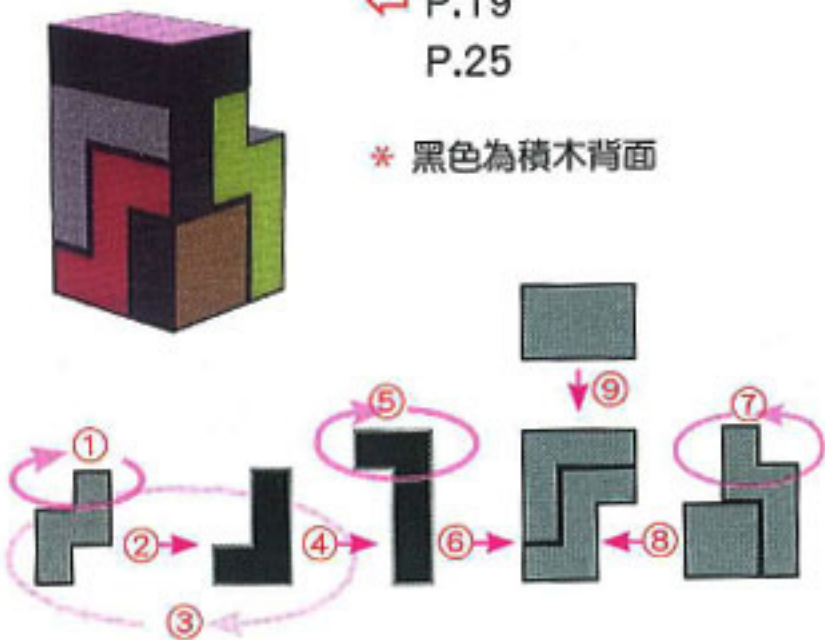

↓ P.20、P.22

* 黑色為積木背面

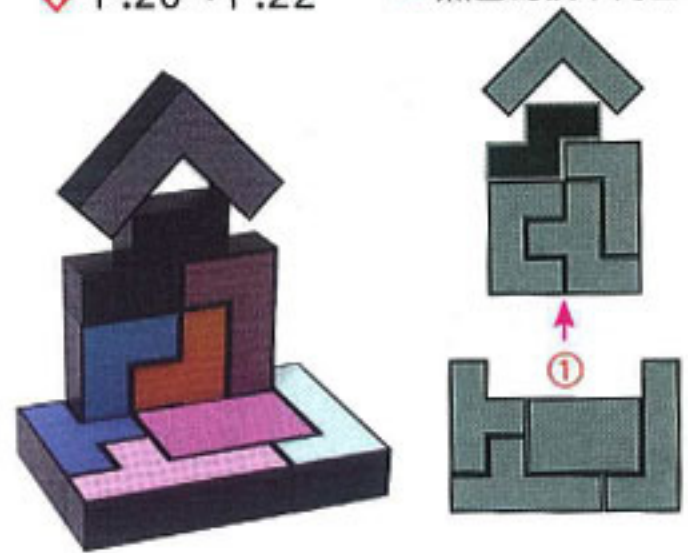

← P.19、P.23

* 黑色為積木背面

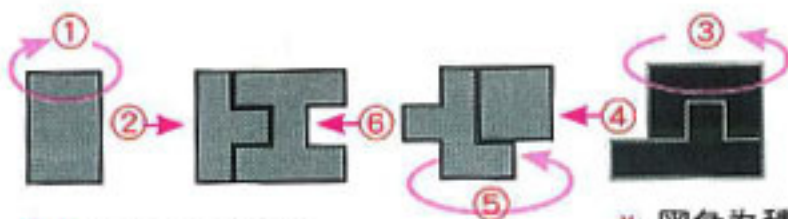

↓ P.21
P.22

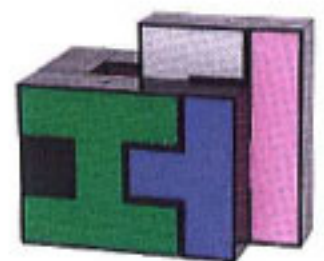
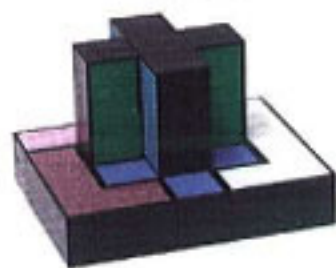

← P.19、P.23

* 黑色為積木背面

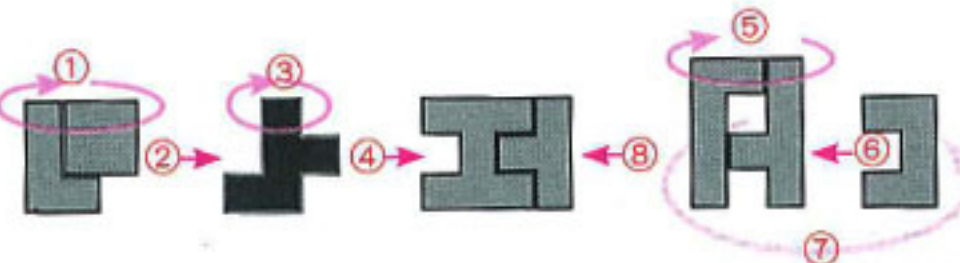

← P.21
P.25

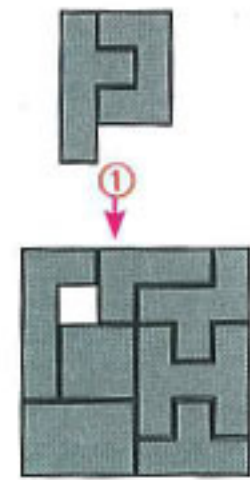

↑ P.21、P.26

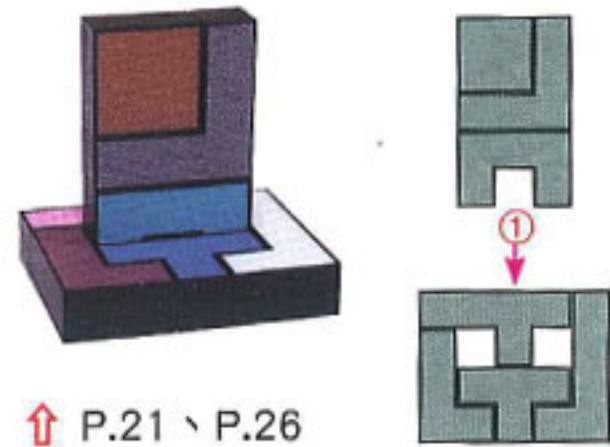

↑ P.20
P.24

* 黑色為積木背面

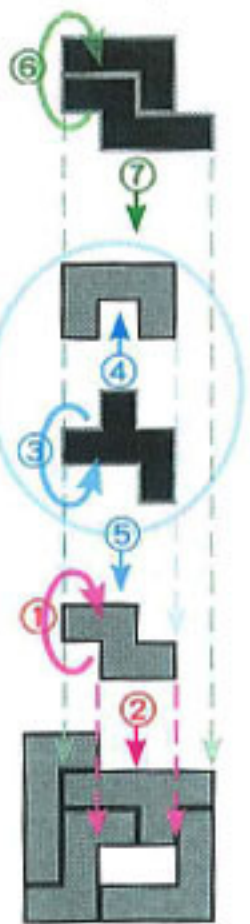

↑ P.21
P.26

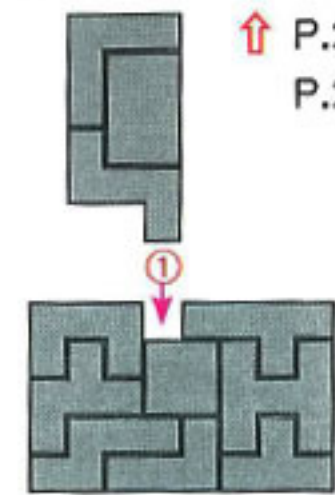
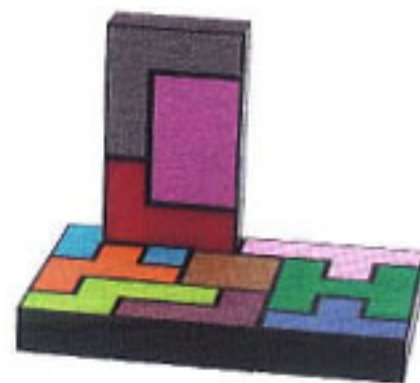

↑ P.20
P.24

* 黑色為積木背面

